



## Inductive sensor

### NMB1,5-8GM35-E2-FE-1M-V1

- Stainless steel sensing face
- Sensing range 1.5 mm
- Ferrous targets
- 3-wire DC
- Pigtail quick disconnect



## Dimensions

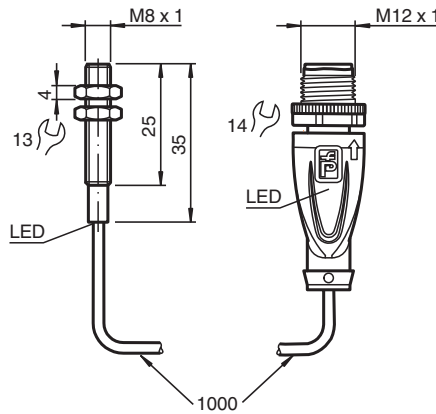

## Technical Data

### General specifications

Switching function		Normally open (NO)
Output type		PNP
Rated operating distance	$s_n$	1.5 mm
Installation		flush
Output polarity		DC
Assured operating distance	$s_a$	0 ... 1.215 mm

Refer to "General Notes Relating to Pepperl+Fuchs Product Information".

Pepperl+Fuchs Group  
www.pepperl-fuchs.com

USA: +1 330 486 0001  
fa-info@us.pepperl-fuchs.com

Germany: +49 621 776 1111  
fa-info@de.pepperl-fuchs.com

Singapore: +65 6779 9091  
fa-info@sg.pepperl-fuchs.com

**PF** PEPPERL+FUCHS

## Technical Data

Actuating element	Ferrous targets	
Reduction factor $r_{Al}$		0
Reduction factor $r_{Cu}$		0
Reduction factor $r_{304}$		0.4 - 0.7
Reduction factor $r_{317}$		1
Reduction factor $r_{Brass}$		0
Output type	3-wire	
<b>Nominal ratings</b>		
Operating voltage	$U_B$	10 ... 30 V DC
Switching frequency	$f$	80 Hz
Hysteresis	$H$	5 ... 15 typ. 10 %
Reverse polarity protection		yes
Short-circuit protection		yes
Voltage drop	$U_d$	$\leq 2$ V
Operating current	$I_L$	$\leq 100$ mA
Current consumption		$\leq 10$ mA
Off-state current	$I_r$	$\leq 10$ $\mu$ A
<b>Indicators/operating means</b>		
Operation indicator	LED red: Output	
<b>Standard conformity</b>		
Standards	EN 60947-5-2:2007 IEC 60947-5-2:2007	
<b>Approvals and certificates</b>		
UL approval	cULus Listed, General Purpose	
CSA approval	cCSAus Listed, General Purpose	
CCC approval	CCC approval / marking not required for products rated $\leq 36$ V	
<b>Ambient conditions</b>		
Ambient temperature	-25 ... 75 °C (-13 ... 167 °F)	
<b>Mechanical specifications</b>		
Connection type	Cable connector M12 x 1 , 3-pin with PUR cable 1 m	
Core cross section	0.14 mm <sup>2</sup>	
Housing material	Stainless steel 1.4305 / AISI 303	
Sensing face	Stainless steel 1.4305 / AISI 303	
Degree of protection	IP67	

## Connection

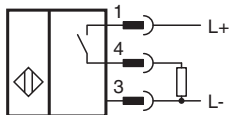



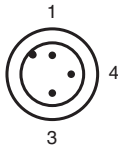

## Connection Assignment



Wire colors in accordance with EN 60947-5-2

1	BN	(brown)
3	BU	(blue)
4	BK	(black)

## Accessories

	<b>V1-G-2M-PUR</b>	Female cordset single-ended M12 straight A-coded, 4-pin, PUR cable grey
	<b>V1-W-2M-PUR</b>	Female cordset single-ended M12 angled A-coded, 4-pin, PUR cable grey
	<b>MH V1-SCREWDRIVER</b>	Torque screwdriver (0.6 Nm)
	<b>MH V1-BIT M12</b>	plug-in cap M12

Release date: 2023-06-13 Date of issue: 2023-06-13 Filename: 914558\_eng.pdf

Refer to "General Notes Relating to Pepperl+Fuchs Product Information".

Pepperl+Fuchs Group  
www.pepperl-fuchs.com

USA: +1 330 486 0001  
fa-info@us.pepperl-fuchs.com

Germany: +49 621 776 1111  
fa-info@de.pepperl-fuchs.com

Singapore: +65 6779 9091  
fa-info@sg.pepperl-fuchs.com